

Bases DOMI para bisagras de enganche rápido clip.  
Regulación **frontal y vertical** mediante excéntrica.

- Para bisagras Serie 100, 200, B y Silentia+.
- Taladro 21+32mm.

### Base DOMI recta modelo **BAP3M**

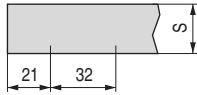
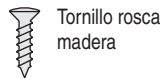

CÓDIGO	REFERENCIA	Altura	Material	Acabado	
30.539	BAP3M09	H0	acero	níquel	300
30.540	BAP3M29	H2	acero	níquel	300
30.541	BAP3M39	H3	acero	níquel	300

### Base DOMI recta modelo **BAP7M**



Taco montaje directo Ø10x11,5mm.

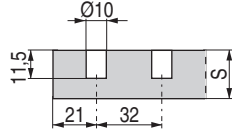

CÓDIGO	REFERENCIA	Altura	Material	Acabado	
30.536	BAP7M09	H0	acero	níquel	300
30.537	BAP7M29	H2	acero	níquel	300
30.538	BAP7M39	H3	acero	níquel	300

### Base DOMI recta modelo **BAP3R**

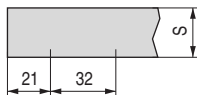
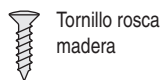
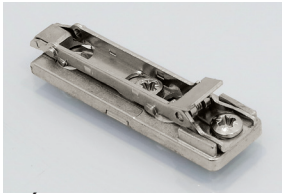

CÓDIGO	REFERENCIA	Altura	Material	Acabado	
30.501	BAP3R09	H0	zamak	níquel	300
30.502	BAP3R39	H3	zamak	níquel	300

### Base DOMI recta modelo **BAPGR**

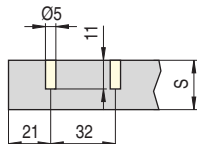
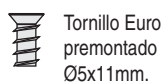
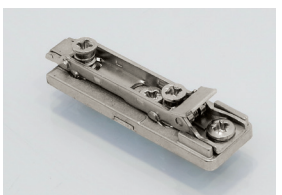

CÓDIGO	REFERENCIA	Altura	Material	Acabado	
30.564	BAPGR09/16	H0	zamak	níquel	300
30.565	BAPGR39/16	H3	zamak	níquel	300

### Base DOMI recta modelo **BAP7R**

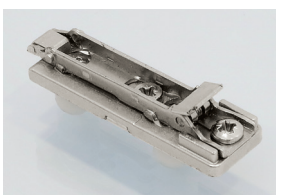

Taco montaje directo Ø10x11,5mm.

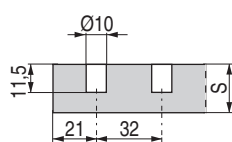

CÓDIGO	REFERENCIA	Altura	Material	Acabado	
30.567	BAP7R39	H3	zamak	níquel	300

Bases DOMI para bisagras de enganche rápido clip.  
Regulación **frontal y vertical** mediante excéntrica.

- Para bisagras Serie 100, 200, B y Silentia+.
- Taladro 37x32mm.

### Base DOMI avión modelo **BAR3R**

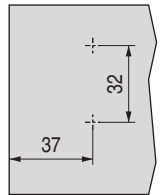
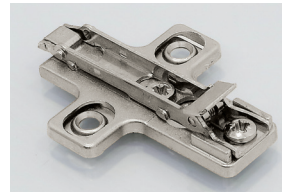

CÓDIGO	REFERENCIA	Altura	Material	Acabado	
30.506	BAR3R09	H0	zamak	níquel	300
30.507	BAR3R39	H3	zamak	níquel	300
30.508	BAR3R69	H6	zamak	níquel	300
30.509	BAR3R99	H9	zamak	níquel	300

### Base DOMI avión modelo **BAR3L**

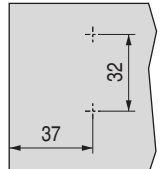
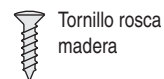
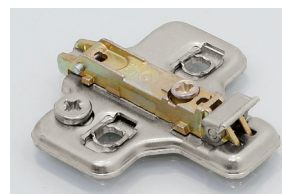

CÓDIGO	REFERENCIA	Altura	Material	Acabado	
30.129	BAR3L09F	H0	acero	níquel	300

### Base DOMI avión modelo **BARGR**

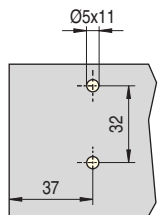
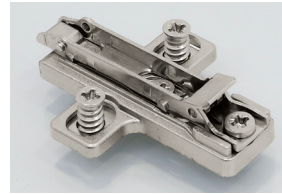

CÓDIGO	REFERENCIA	Altura	Material	Acabado	
30.217	BARGR39/16	H3	zamak	níquel	300

### Base DOMI avión modelo **BAR4R**

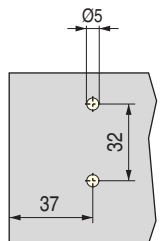
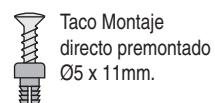
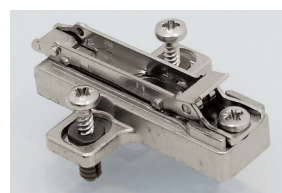

CÓDIGO	REFERENCIA	Altura	Material	Acabado	
30.512	BAR4R09/16	H0	zamak	níquel	300
30.513	BAR4R39/16	H3	zamak	níquel	300
30.514	BAR4R69/16	H6	zamak	níquel	300

### Base DOMI avión modelo **BAR7R**

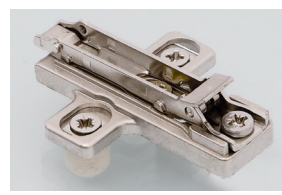

Taco montaje directo Ø10x11,5mm.

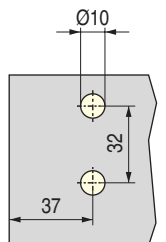

CÓDIGO	REFERENCIA	Altura	Material	Acabado	
30.515	BAR7R39	H3	zamak	níquel	300

Bases DOMI para bisagras de enganche rápido clip.  
Regulación **frontal** mediante excéntrica.

- Para bisagras Serie 100, 200, B y Silentia+.
- Taladro 37x32mm.

Base DOMI avión modelo **BAV3M**

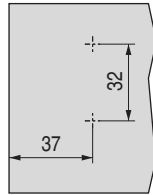
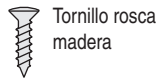

CÓDIGO	REFERENCIA	Altura	Material	Acabado	
30.546	BAV3M09F	H0	acero	níquel	300
30.547	BAV3M39F	H3	acero	níquel	300

Base DOMI avión modelo **BAV4M**

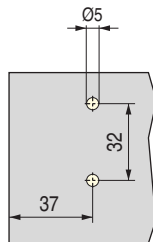
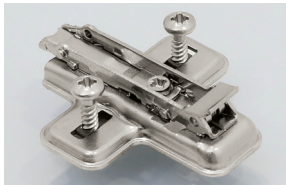

CÓDIGO	REFERENCIA	Altura	Material	Acabado	
30.549	BAV4M39F/16	H3	acero	níquel	300

Base DOMI avión modelo **BAV7M**

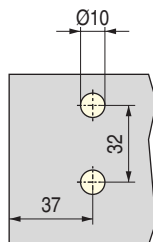

- Códigos con letra **V** se piden por encargo.

CÓDIGO	REFERENCIA	Altura	Material	Acabado	
30.556V	BAV7M09F	H0	acero	níquel	300
30.557	BAV7M39F	H3	acero	níquel	300

Bases DOMI para bisagras de enganche rápido clip.  
Regulación **frontal** mediante excéntrica.

- Para bisagras Serie 100, 200, B y Silentia+.
- Taladro 37x32mm.

Base tradicional avión modelo **B2VG**

Especialmente indicada para colocar en las bisagras mod. Raiza, apertura 270° para puertas embutidas.

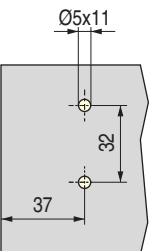

CÓDIGO	REFERENCIA	Altura	Material	Acabado	
30.560	B2VGBV9/16	H18	zamak	níquel	300

Bases tradicionales **simétricas** para bisagras.  
Regulación **vertical** ± 2mm.

- Para bisagras Serie 100, 200, B y Silentia+.
- Taladro 37x32mm.
- Las bases con valor negativo se pueden utilizar únicamente en bisagras de codo D, G y P.

Base tradicional avión modelo **B2V3**

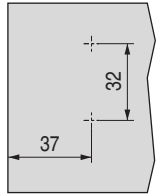
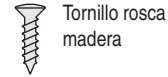

CÓDIGO	REFERENCIA	Altura	Material	Acabado	
30.525	B2V3HS9/15	H - 2	acero	níquel	600
30.526	B2V3H09/15	H0	acero	níquel	600
30.527	B2V3H39/15	H3	acero	níquel	600
30.528	B2V3H69/15	H6	acero	níquel	600
30.529	B2V3H99/15	H9	acero	níquel	600

Base tradicional avión modelo **B2V7**

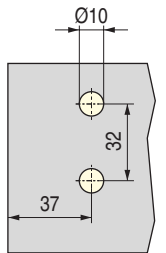
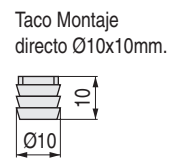

- Códigos con letra **V** se piden por encargo.

CÓDIGO	REFERENCIA	Altura	Material	Acabado	
30.531	B2V7H09/15	H0	acero	níquel	600
30.532	B2V7H39/15	H3	acero	níquel	600
30.533V	B2V7H69/15	H6	acero	níquel	600

Bases tradicionales **asimétricas** para bisagras.  
Regulación **vertical** ± 2mm.

- Para bisagras Serie 100, 200, B y Silentia+.
- Taladro 28x32mm.

Base tradicional avión modelo **B2S3B**

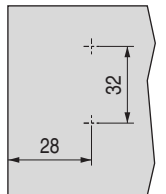

CÓDIGO	REFERENCIA	Altura	Material	Acabado	
30.134	B2S3B69/15	H6	zamak	níquel	600
30.128	B2S3B99B6	H9	zamak	níquel	600

Base tradicional avión modelo **B2S3**

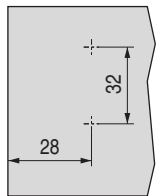

CÓDIGO	REFERENCIA	Altura	Material	Acabado	
30.248	B2S3H09/15	H0	acero	níquel	600

Bases tradicionales inclinadas para bisagras.  
Regulación **vertical**  $\pm 2\text{mm}$ .

- Para bisagras Serie 200 de ángulo especial
- Válidas para montajes especiales y posiciones intermedias. En combinación con los diversos codos de las bisagras, ofrecen innumerables soluciones de montajes angulares para las puertas.

### Base ESPECIAL INCLINADA 15° avión modelo **B2V3**

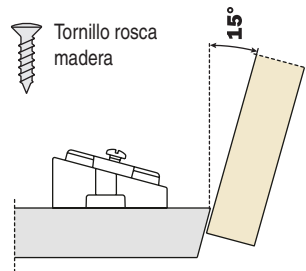

CÓDIGO	REFERENCIA	Altura	Material	Acabado	
30.561	B2V3BW9/15	15°	zamak	níquel	600

### Base ESPECIAL INCLINADA +7,5° avión modelo **B2V3**

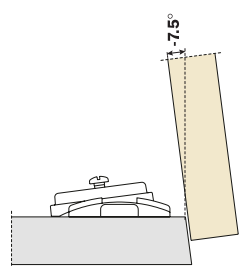
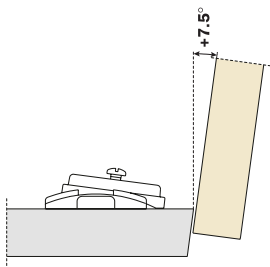
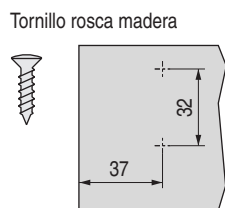

CÓDIGO	REFERENCIA	Altura	Material	Acabado	
30.562	B2V3BW9R/15	-7,5° / +7,5°	zamak	níquel	600

### Base ESPECIAL INCLINADA +10°/+30° avión modelo **B2V3**

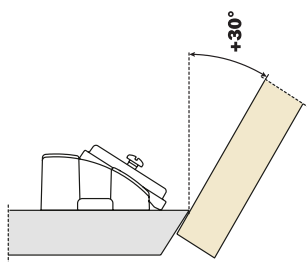
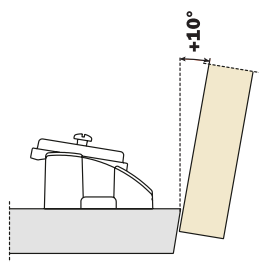
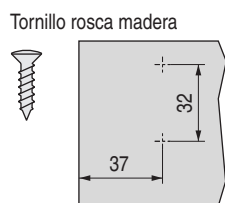

CÓDIGO	REFERENCIA	Altura	Material	Acabado	
30.563	B2V3BW9S/15	+10° / +30°	zamak	níquel	300

Ejemplos de montajes con ángulos especiales:  
La distancia de taladro de las bases inclinables varían al variar el ángulo de utilización.

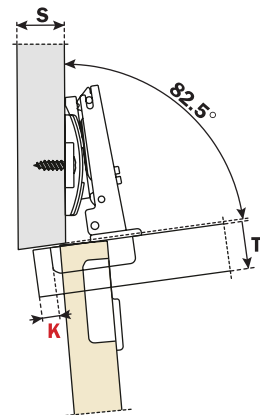

CON BASE 30.562

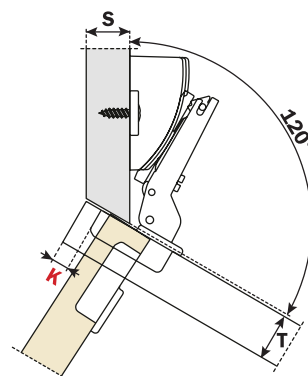
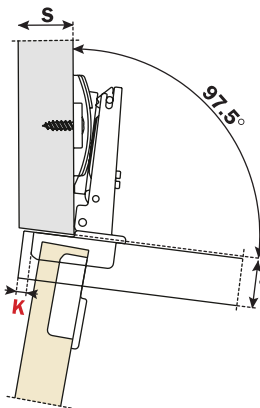

CON BASE 30.563

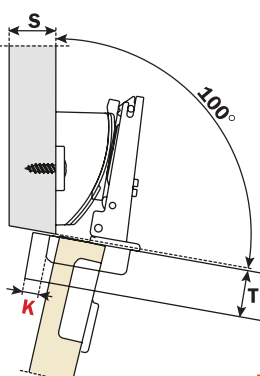

Tapa cubrecazoleta para bisagras SALICE



- Cubrecazoleta de acero níquelado.
- Válido para todas las bisagras SALICE serie 100, 200, 700 y Silentia+.

CÓDIGO	REFERENCIA	Material	Acabado	
30.120	S2XX85H9	acero	níquel	3.000

Tapa cubrebrazo para bisagras SALICE



- Cubrebrazo simétrico de acero níquelado.
- Válido para todas las bisagras SALICE serie 100, 200, 700 y B.

CÓDIGO	REFERENCIA	Material	Acabado	
30.124	S2BX83H9	acero	níquel	3.000

Topo de apertura para bisagras de 94° SALICE



- Limita la apertura de la bisagra a 86°.
- Válido para todas las bisagras SALICE con apertura 94° y cazoleta de 35mm.

CÓDIGO	REFERENCIA	Material	Acabado	
30.29	S2A637XF	hierro	zincado	500

Broca Ø35,5 especial para bisagras



- Broca especial de metal duro.
- Válida para cualquier bisagra del mercado con cazoleta de 35mm.
- Códigos con letra **V** se piden por encargo.

CÓDIGO	Material	Acabado	
30.21V	acero	negro	1

SUPLEMENTO 1,8mm. para bisagras SALICE

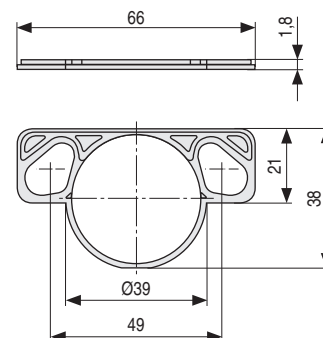

- Válido para reducir la profundidad de taladro en bisagras de apertura 94° y 110°.

CÓDIGO	REFERENCIA	Material	Acabado	
30.18	S2XX86KT	plástico	transparente	1.200

Broca Ø35 universal para bisagras



- Broca especial de metal duro.
- Válida para cualquier bisagra del mercado con cazoleta de 35mm.

CÓDIGO	Mano	Material	
301.486	derecha	acero	1
301.487	izquierda	acero	1