

**GRADA** Plataforma giratoria

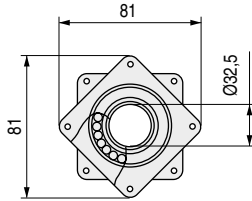

**JALEA** Plataforma giratoria

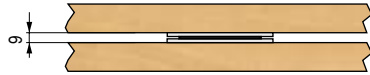
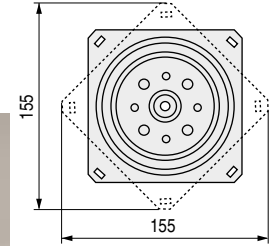
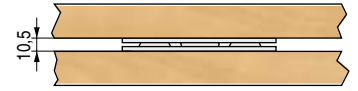

CÓDIGO	Carga máxima	Material	Acabado	
1050.20	80kg.	hierro	zincado	50

CÓDIGO	Carga máxima	Material	Acabado	
1050.34	150kg.	hierro	zincado	25

**ALBORA 240** Plataforma giratoria

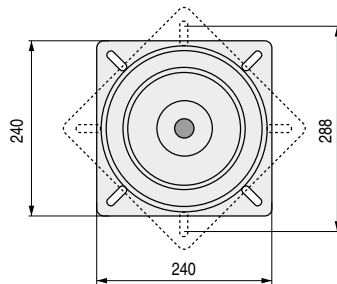
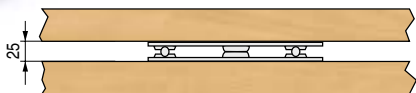

**ALBORA 330** Plataforma giratoria

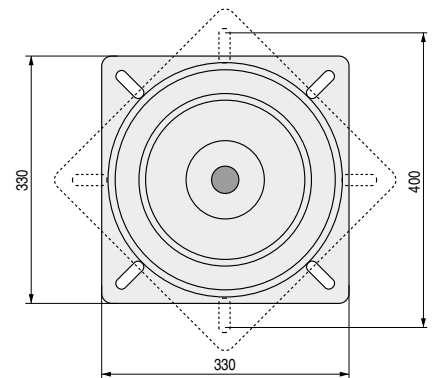

- Plataforma giratoria muy robusta y resistente. Espesor de la chapa 3mm.
- Para aplicar en bases giratorias de madera, bases de sillones tapizados etc...

- Plataforma giratoria muy robusta y resistente. Espesor de la chapa 3mm.
- Para aplicar en bases giratorias de madera, bases de sillones tapizados...

CÓDIGO	Carga máxima	Material	Acabado	
1440.3	280kg.	hierro	negro	6

CÓDIGO	Carga máxima	Material	Acabado	
1440.2	300kg.	hierro	negro	6