

Bisagra S200 Apertura 105° PARA PUERTAS DE PERFIL METÁLICO
Adecuadas para puertas con marco de aluminio.

SALICE

Adaptables a todas las bases tradicionales **Serie 200** y a todas las bases **DOMI** de enganche rápido.







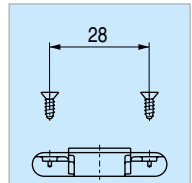

Tornillos autotaladrantes
DIN 7504-P Ø3,5X11mm.

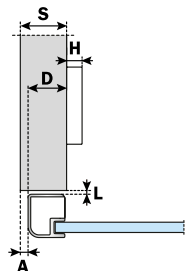
Zincado

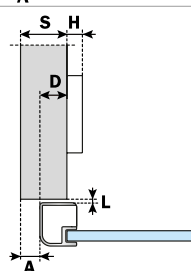

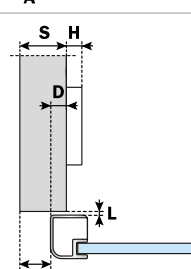
Cód. 914.53 1.000

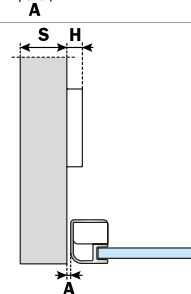

 <p>RECTO</p>	 <p>Codo 0</p>	<p>C2Z6A99 30.231</p> <p>150 </p>
 <p>SEMIACODADO</p>	 <p>Codo 5</p>	<p>C2Z6D99 30.232</p> <p>150 </p>
 <p>ACODADO</p>	 <p>Codo 9</p>	<p>C2Z6G99 30.233</p> <p>150 </p>
 <p>SUPERACODADO</p>	 <p>Codo 17</p>	<p>C2Z6P99 30.234</p> <p>150 </p>

Medidas para el mecanizado en un perfil de aluminio estándar

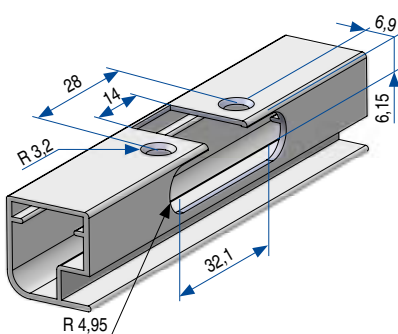

Gracias a sus dimensiones reducidas, las bisagras para perfil metálico permiten la utilización de perfiles con espesores y anchos reducidos. Los cristales se pueden colocar con juntas de gomas, garantizando así la falta de ruido, facilidad de montaje y rápida sustitución del cristal.

Actualizado 29-08-19

NADIR Perfil de aluminio en barra sin mecanizar

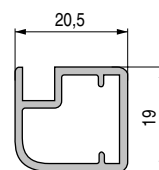

• Escuadras y tornillos para el montaje de los perfiles, ver en grupo 7.

CÓDIGO	Material	Acabado	
9081.111	aluminio	anodizado plata mate	1 barra