

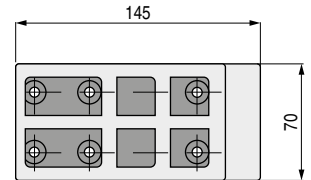

DRAKA Pata de plástico cromo
H83

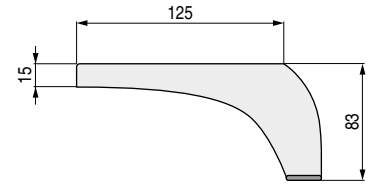
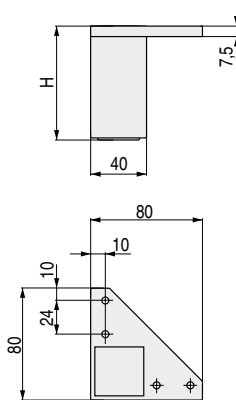

CÓDIGO	Material	Acabado	
1037.59	plástico	negro-cromo	70

CUMBRE Pata de plástico 40x40



CÓDIGO	H	Material	Acabado	
9080.100	100	plástico	gris RAL 9006	100
9080.102	80	plástico	gris RAL 9006	60

OKA Pata de plástico ABS

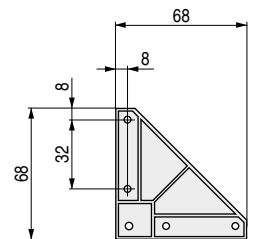
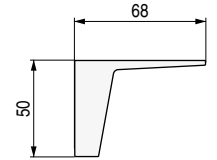

CÓDIGO	Material	Acabado	
1315.11	plástico	antracita	100

FENDER Base pata plástico 80x80

H16

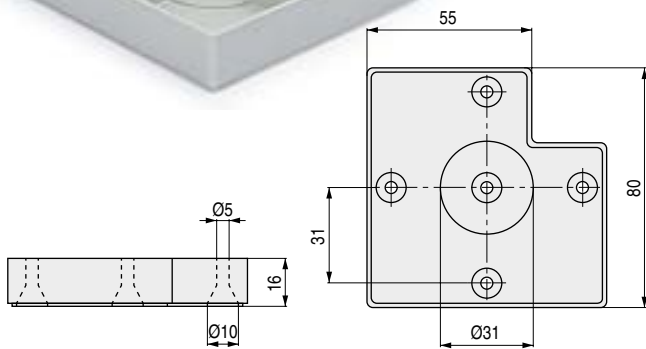

CÓDIGO	Material	Acabado	
570.102	plástico	gris RAL 9006	500

URIA Pata cuadrada de plástico 45x45

H30

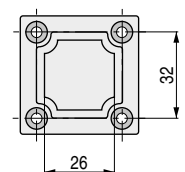
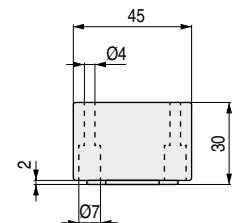

CÓDIGO	Material	Acabado	
570.103	plástico	gris RAL 9006	500