

### INSIGNIA Bisagra inglete 120°

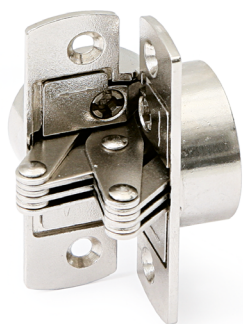

- Inglete de 45°.
- Ajuste en altura de 3mm., ajuste en ancho y profundidad 1,5mm.
- Grosor de la puerta 16 a 22mm.
- Grosor de pared lateral 16 a 20mm., a partir de 20mm. es preciso biselar el canto 3mm.

CÓDIGO	Material	Acabado	
1210.128	zamak-acero	níquel	200

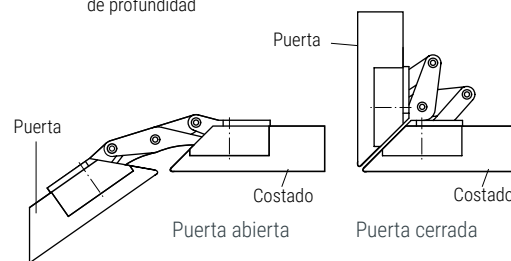
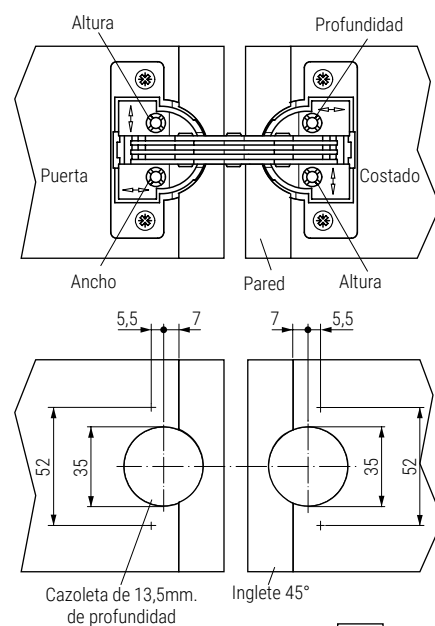

### VERA SRP Bisagra plana sin remate

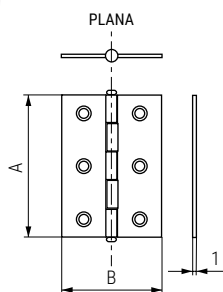

- Para otros acabados o materiales, consultar.

CÓDIGO	A	B	Material	Acabado	
851.42	25	25	hierro	latonado	24
851.45	40	35	hierro	latonado	24
851.61	40	35	hierro	níquel	24
851.62	50	40	hierro	níquel	24
851.63	60	40	hierro	níquel	24
851.64	70	50	hierro	níquel	24
851.101	40	35	hierro	zincado	24
851.104	60	40	hierro	zincado	24

### HI-FI Bisagra puerta de cristal

#### Con casquillo

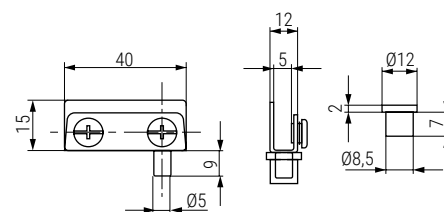
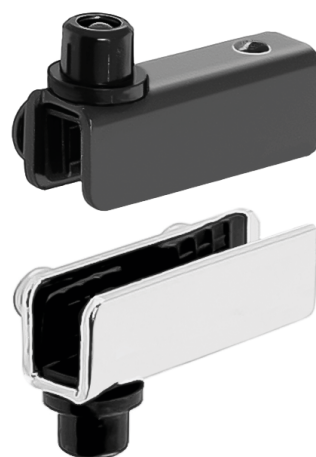

- Para grosores de cristal de 5mm.
- Casquillos y tornillos de ajuste de plástico.
- Se sirven por juegos, una bisagra superior y una inferior con dos casquillos.

CÓDIGO	Material	Acabado	
9030.146	hierro	chromo	500 juegos
9030.246	hierro	grafito	500 juegos