

## KRABY DESK Compás apertura de puertas descendentes para escritorio



**KRABY DESK** el compás de nueva generación con diseño innovador, creado para la apertura de puertas descendentes. Ideal para crear una practica mesa de escritorio.

**Rápida y fácil instalación.** Hay que insertar el pistón en el soporte de la puerta y luego hacer una ligera presión (clic) contra el soporte lateral.

El pistón **KRABY** no lleva incluidos los soportes de fijación al costado. Pedir por separado.

Fabricado en acero y zamak.  
Modelo PATENTADO.

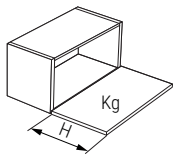
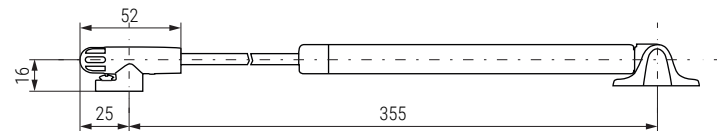
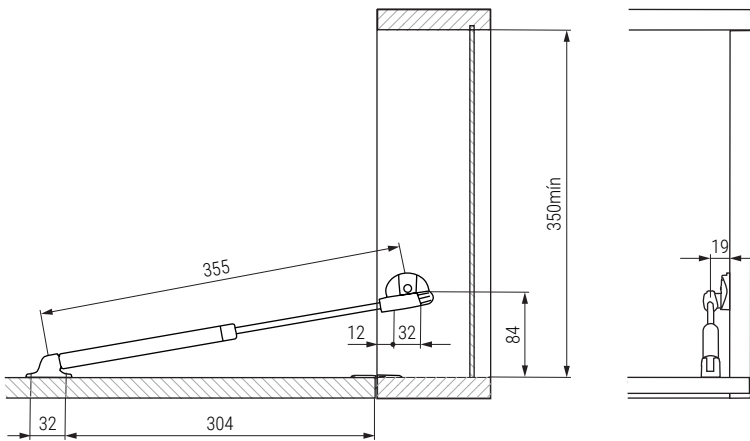

H	Peso de la puerta Kg.												
	1	2	3	4	5	6	7	8	9	10	11	12	
380-450													2xKrabby
451-550													2xKrabby



CÓDIGO	Material	Acabado	
504.641	zamak-acero	níquel-gris	1/50

### Soporte costado KRABY Montaje tirafondo

### Soporte costado KRABY Montaje directo, taco 5mm.

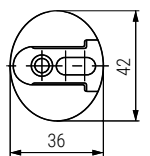
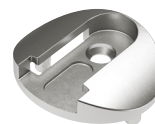
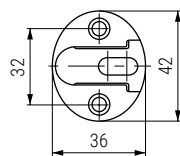

CÓDIGO	Material	Acabado	
504.44	zamak-acero	níquel	100

CÓDIGO	Material	Acabado	
504.59	zamak	níquel	100

### Información y Complementos recomendados



Cód. 504.514



Cód. 504.632

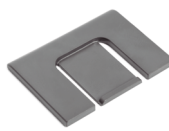

Cód. 504.633



Video



Ficha técnica