

PUENTE Grapa puente Tube-clip

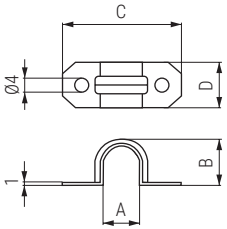

Código Code	A	B	C	D	Material Material	Acabado Finish	
1333.33	8	10,5	38	20	acero/steel	zincado/zinc	200
1333.38	10	12	35	13	acero/steel	zincado/zinc	200

CIAL Cierre aldaba para mesas Hook bolt for table

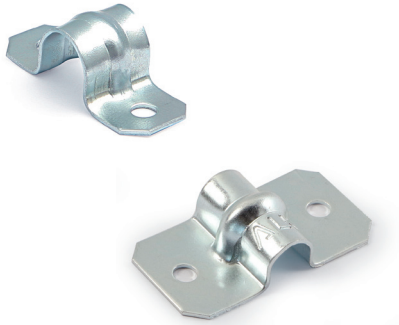
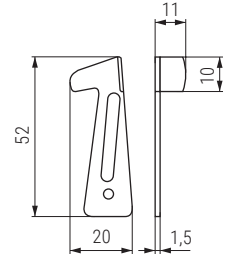
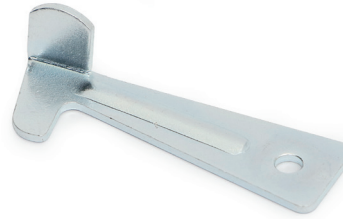

Código Code	Material Material	Acabado Finish	
9030.161	acero/steel	zincado/zinc	1.500

ZAO Pletina soporte plana con un lado curvado Support plate

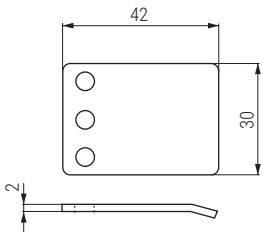

Código Code	Material Material	Acabado Finish	
50.28	acero/steel	zincado/zinc	200

ENRE Enganche redondo para mesa Round block for table

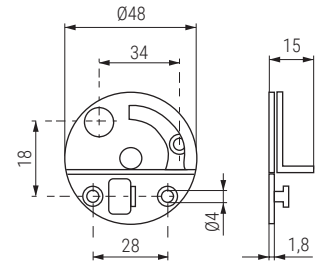

ACTUALIZADO EN CATALOGO 10/05/2024

Código Code	Material Material	Acabado Finish	
415.127	acero/steel	zincado/zinc	100
415.27	acero/steel	zincado/zinc	100

DISALA Soporte deslizante para ala de mesa oculta Support - Rolling unit

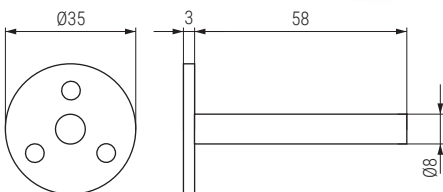
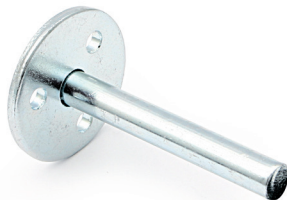

Código Code	Material Material	Acabado Finish	
1333.31	acero/steel	zincado/zinc	300

GAMBLO Gancho de bloqueo para mesa Hook bolt for table

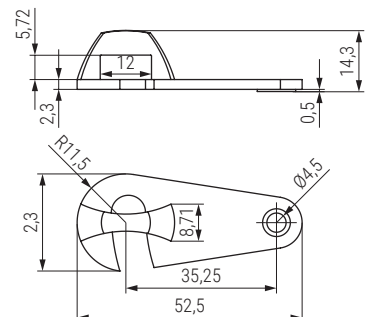
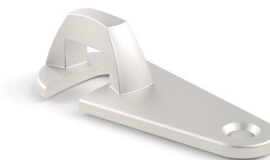

Código Code	Material Material	Acabado Finish	
731.51	zamak	nickel plated	100